



B.E.G. LUXOMAT®

Operating and mounting instruction B.E.G. for motion detector Indoor 180-R/2Wire with battery

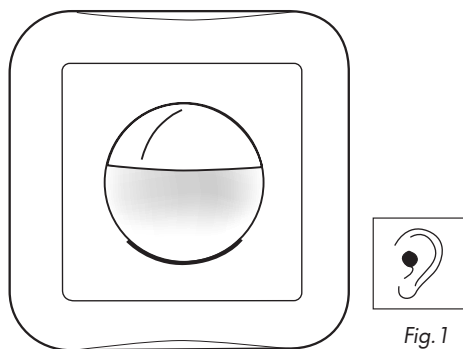

Fig. 1

CAUTION: have all work involving the 230 V mains supply carried out by a qualified electrician! Before starting disconnect the mains!

Type	Part number
Indoor 180-R, fully fitted, pure white (relay version)	92616

1. Function

With the **LUXOMAT®** Indoor 180 you have chosen a **B.E.G.**-motion detector for flush mounting in indoor applications. The **LUXOMAT®** Indoor 180 is an automatic switching device which operates on the principle of infrared technology. It continuously measures the ambient temperature and the ambient lightlevel and compares it with the infrared radiation emitted from any moving form which enters its detection zone. Any differential results in automatic switching, provided the lightlevel is beyond a preset lightlevel.

Contrary to other motion detectors which reacts to moving heat sources only, with the **LUXOMAT®** Indoor 180 you will not be left in the dark unless there is no more motion because through a combination with an acoustic sensor, it reacts additionally to noises.

The sensor owns 2 red LED's:

- LED 1**
- Display of detected motion in standard operation
 - Display of actual light value
 - Battery state: low/2 h load state
- LED 2**
- Detection of acoustics

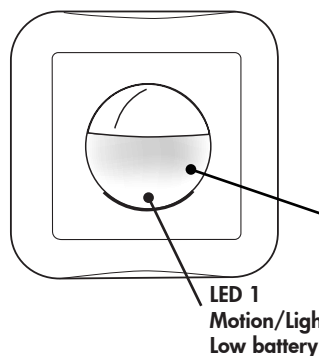

Fig. 2

Furthermore the unit has a photo electric switch, a acoustic sensor and a time switch. Light value, acoustic sensor and timer are adjustable as follows:

Detecting movement

The sensitivity of **LUXOMAT®** Indoor 180 has been designed to detect the human form including of course children and it is therefore possible that some animals, principally large dogs, will

also switch the system. This is unavoidable but, in most instances, offers an advantage as unwanted animals are frightened away by sudden lighting. As long as motions are detected the connected lights remain switched on. When there is no more motion the light is switched off after the preadjusted time. 3 sec. only after switching off the **LUXOMAT®** Indoor 180 can be activated again by motions.

The **LUXOMAT®** Indoor 180 is equipped with a semiballsizes-fresnel lens which gives a semicircular detection field (horizontally appr. 180°, vertically appr. 60°). With regard to the recommend fixing height of 1.10 - 2.20 m and to a motion transversally to the lens segments the radius of the detection field is appr. 10 m.

Acoustic function

As long as the acoustic sensor receives noises e.g. by speech or music the **LUXOMAT®** Indoor 180 remains switched-on even when there are no more motions – the light stays on. Every noise and every motion retrigger the unit again for the period of preselected time. Unless there is no more motion and no more noise the **LUXOMAT®** Indoor 180 switches off the light automatically.

Immediately thereafter the Indoor 180 can be switched on again e.g. by calling when this is been done within a period of 8 sec. However the Indoor 180 has not been activated for a longer period, then the unit can be retriggered only by a motion. This combination protects the unit to be switched on by unwanted noises.

2-wire – installation:

The Indoor 180-R/2W model has been specifically designed to replace manually operated light-switches in so called 2-wire installation. 2-wire installations pose the problem that once the relay turns ON the connected luminaires, the power supply for the sensor is cut-off. The solution to this problem is the use of a rechargeable battery which will be charged while the luminaires are OFF and which will supply the sensor while the luminaires are switched ON.

In ON state the sensor will draw power from the battery and constantly monitor the battery voltage. Once the battery voltage drops to a defined LOW BATTERY value, the sensor will switch OFF the relay and enforce a 2 hrs long charging period. The LED-1 will quickly flash!

(Please note: during this 2 hrs-period, the unit remains OFF and will not react to any movement or sound). If no mains supply is present, the battery will discharge further and at some point in time the deep discharge protection will kick in and shut down the sensor entirely.

2. Prior to Installation:

Before installation the following has to be considered:

- The **LUXOMAT®** Indoor 180 is designed for the installation in standard switch flush mount boxes size 1.
- No parallel installation of more than 8 units is allowed/recommended.
- The connected lamp load must not exceed the default values.
- There must not be any obstacles in the view of the sensor, since infrared rays cannot penetrate solid materials.
- The **LUXOMAT®** Indoor 180 is an automatic light switch which cannot be used in intrusion applications.

Selection of fixing place:

The optical system of the **LUXOMAT®** Indoor 180 is designed for fixing heights of 1.10 to 2.20 m.

A typical application is the replacement of a wall switch in appr. 1.10 m height or for room surveillance in about 2 m height (pt. 6).

Additionally to the horizontal detection plane the Indoor 180 has a vertical detection plane which detects also movements underneath the motion detector. The maximum range is 10 m, independently of fixing height. The range cannot be adjusted electronically or manually, instead unwanted detection areas have to be eliminated by adhesive tape that must be put on the corresponding lens segments.

Frontal approach

To get a satisfying functioning of the motion detector the following typical property of infrared motion detectors must be considered:

Motion detectors are most sensitive when motions are across the detection zones. In case of a frontal approach the sensitivity and hence the range is considerably reduced (pt. 5).

3. Installation

The detector can be installed in conventional installation sockets. Installation should be made to a wall with a height of 1.10 to 2.20 m.

For the combination with switches of leading manufacturers the enclosed additional blinds can be used. For installation of the Indoor 180 proceed as follows:

Mounting diagram

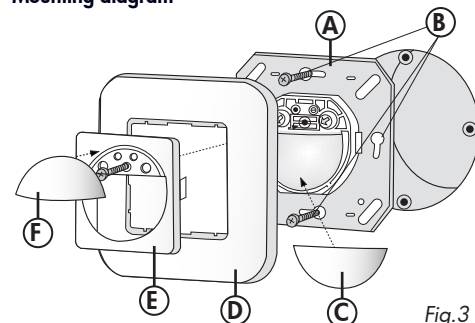

Fig. 3

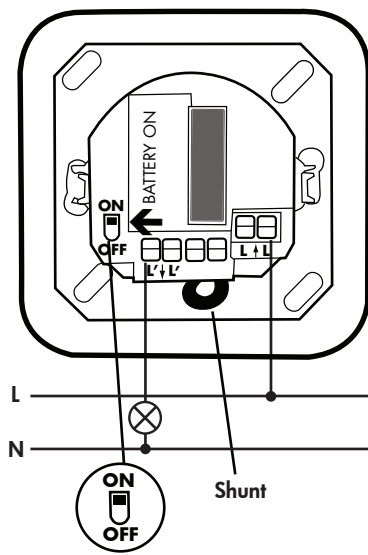

Fig.4

Setting into operation:

Note:
The battery is in most cases discharged due to prolonged period of storage and requires charging!
Connect the detector according to the regulations and as shown in the wiring diagrams (Fig.4).

- Note:**
There is a pre-inserted shunt (thick wire). In normal operation this shunt must be installed! Do not remove!
- Depending upon the concealed housing, fasten at the top and the bottom or left and right using the enclosed screws (B).
 - Additionally to the horizontal detection plane the Indoor 180 has a vertical detection plane which detects also movements underneath the motion detector. In order to prevent detection within the vertical range of coverage, apply cover (C).
 - Next introduce and fasten the blinds (D) and the covering-cap (E).
 - Switch on mains' voltage. The LUXOMAT® Indoor 180 is ready for use after having completed a self-checking cycle of about 60 seconds.
 - Settings of the operating time and twilight value.
 - Mount covering-cap (F).
 - The covering-cap (F) can be removed as shown in the drawing.

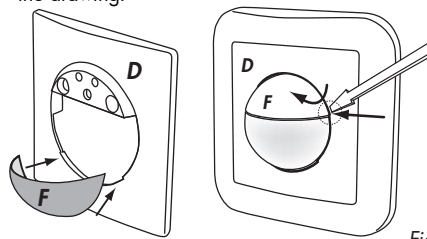

Fig.5

For outdoor installations additionally the IP54-accessory-fixing-set has to be mounted (Part nr. 92139).

- The following scenarios are possible when putting detector into operation:

Scenario A:
Battery is discharged! - Lights remain OFF! LED-1 shall light up and flash quickly to indicate LOW BATTERY and sensor will remain for 2 hrs in charging mode = relay OFF.

Scenario B:
Battery is sufficiently charged! - Lights turn ON LED-1 shall light up and flash slowly for start-up period of 60secs. After start-up period unit is operational.

Scenario C:
Battery is discharged! - BUT light turn ON!
LED-1/LED-2 do not flash, relay does not switch! In this unlikely case the unit cannot recover without removing the SHUNT:
Turn OFF 230 VAC mains supply and remove shunt, than reconnect 230 VAC.
Without shunt installed, the load is disconnected from the relay and regardless of relay state, charging should resume and LED-1 should flash quickly (perhaps with some delay).

Actions in szenario A + C:

Let the unit charge for approx. 10 mins.
The battery shall have recharged sufficiently to allow a few minutes of sensor operation.
Then for Szenario C, disconnect 230 VAC and install shunt, and connect 230 VAC again.

For A + C now press the RESET button (near MIC control). Since the battery is charged to nominal voltage, the unit will reset and enter the start-up period (LED-1 slow flashing).
After 60 secs the unit is operational and settings can be performed as described below.

4. Adjustments of twilight-switch / timer and acoustic-sensor

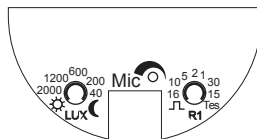

4.1 Twilightswitch:

The twilight-level can be set between approx. 2 to 2000 Lux.

- Night operation (dark only)
- Day and night operation

4.2 Timer (R1)

- The delay timer can be adjusted from 15 secs to 16 mins
- TEST: Use this mode for setting up operation. Every movement will cause relay to switch ON for 1sec and than OFF again: walktest LED-1 shows the current lux-level
- Symbol Pulse/chime function
Every motion will turn ON relay for 1 sec followed by a pause. (The next pulse can only occur after pause!) In pulse mode, there is no need for MIC/ acoustic detection. The MIC-control has therefore an alternative function, it determines the duration of pause following a pulse:
MIC-control = min = 9secs
MIC-control = 50% = 30secs
MIC-control = max = 60secs

4.3 Noise sensitivity

Fully counter-clockwise means highest sensitivity. Fully clockwise means noise detector switched off. Intermediate values to be adjusted accordingly to local conditions. Functioning of the noise detector will be indicated by a LED located behind the lens.
Lighting of the LED means the noise detector is functioning and triggers the timer again.

5. Detection area

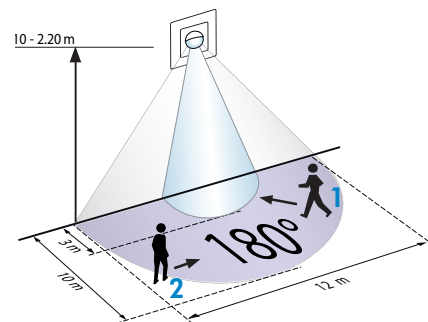

- 1 ■ Walking towards
- 2 ■ Walking across

6. Technical data

- Supply voltage 230 VAC ±10%
- Accu 5 x NiMH/30AAAAH
1,2 V / 200 mAh
- Detection angle 180° horizontally/
60° vertically
- Switching power
 - Ohmic load 2300 W, cosφ= 1
 - Induktive load 1150 VA, cosφ= 0.5
 - Halogenlamps with transformer 1000 VA
- Range (1.10 - 2.20 m mounting height):
max. 10 m for lateral walking
appr. 3 m for frontal walking
- Time settings impulse, 15 sec. - 16 min.
- Photo electric switch e.g. 2 - 2000 Lux
- Dimensions L x W 87 x 87 mm
Installation depth 36 mm
- Protection / class IP20, II
- Housing Polycarbonate
- Ambient temperature +5°C to +45°C

8. Electromagnetic Compliance (EMV)

When positioned within the direct vicinity of high powered radio transmitting equipment (e.g. portable phones, H.A.M., taxi, police, fire, ambulance, radio operators etc.) false activation switching may be experienced. However, this influence will not damage the sensor's electronics. The automatic switching of the sensor will be switched off as soon as the source of radio interference stops transmitting.

9. Trouble shooting – Practical hints

1. Lamp does not light up

- Tungsten halogen lamp defective
Replace tungsten halogen lamp
- No mains connection
Check connection by qualified electrician
- Incorrect setting of lux level
Correct setting of lux level
- Unit mounted too high
Mount at recommended height
- PIR detector lens obstructed by dirt or other objects
Clean lens or remove objects
- Main fuse defective
Check or replace by qualified electrician

2. Delayed lamp activation

- Mounted too high
Mount at height stated in specification (1.10 - 2.20 m)
- Direct line of approach
Re-direct walking so that the approach is not frontally

3. Lamp stays on continuously

- Continual thermal activity detected ie. extractor fan, central heating ducts
Check for any activity which could cause unit detection to be maintained
- Delay time set too high
Reduce time delay
Check ambient noise-level, if necessary switch off noise-sources

4. Limitation of range (not up to the minimum specification)

- Mounted too high
Correct mounting height
- Temperature difference between ambient temperature and source of heat too small
No improvement possible
- Direction of movement aimed directly at lens of motion detector
Move laterally to detector