

Contents

1.	GENERAL	1
1.1	KNX bus basics	1
1.2	Overview	1
1.3	Symbols	1
2.	OCCUPANCY DETECTOR BASICS	2-3
2.1	Introduction	2
2.2	Motion detection with the B.E.G. KNX occupancy detector	2
2.3	Difference between occupancy and motion detectors	2
2.4	Switching mode and regulating mode	2
2.5	Light analysis	2
2.6	Detector operating modes	3
2.7	Detector functional groups	3
3.	IR REMOTE CONTROL	3-4
3.1	Special functions	3
3.2	Operating modes and remote control buttons	3-4
4.	GENERAL SETTINGS	5
4.1	Activate/deactivate outputs	5
4.2	Test mode	5
4.3	LED	5
4.4	Safety pause	5
5.	LIGHT OUTPUT SETTINGS	5-12
5.1	Basic settings	5
5.2	Output type	5-6
5.3	"Follow-up time" parameters	7
5.4	Daylight-dependent switch-off	7
5.5	Manual control options	7-8
5.6	Brightness threshold 1 and 2 (switching) or set value 1 and 2 (regulating)	8-9
5.7	Change trigger function	9
5.8	Dynamic semi-automatic mode / daylight-dependent resetting	9
5.9	Manual switching-on in case of sufficient ambient light / forced shutdown (switchoff)	9-10
5.10	Centralised switching	10
5.11	Corridor function	10
5.12	Locking function	10
5.13	Bus voltage return	10-11
5.14	Additional functions in regulating mode	11-12
5.14.1	Regulation (dimming) of two light groups (offset)	11
5.14.2	Soft start	11-12
5.14.3	Orientation light	11
5.14.4	Burn-in function for fluorescents	12
5.14.5	Regulation cycle time (cycle-time for controlling)	12
5.14.6	Regulation minimum	12
5.15	Additional functions in switching mode	12
5.15.1	Send ON-telegrams during follow-up time	12
6.	HVAC OPERATION	12-14
6.1	Introduction	12
6.2	Differences between light output and HVAC channels	12-13
6.3	Delayed switch-on	13-14
7.	OCCUPANCY-INDEPENDENT REGULATING MODE	14-15
8.	MASTER-SLAVE SYSTEMS / OCCUPANCY DETECTORS IN SLAVE MODE	15-16
8.1	Special case: Master-Master system	15-16
9.	LIGHT SENSOR SETTINGS	16
9.1	Reflection Factor	16
9.2	Sending the light value / correction value	16
10.	COMMUNICATION OBJECTS	17

1. GENERAL**1.1 KNX bus basics**

To understand these instructions, it is assumed that a KNX commissioning or configuration course has been taken.

In order to work with the **B.E.G.** applications, you must first import them into ETS. ETS from version 3.0f is supported.

1.2. Overview

Application: BEG_Praesenzmelder_928xx_V5.0.vd4

The application runs on the following **B.E.G.** detectors (updated: August 2014): 92880, 92881, 92882, 92883, 92884, 92885, 92886, 92887, 92888, 92889, 92892, 92893, 92894, 92895

The application includes the following functions:

- one light output (can be regulated or switched on/off)
- three independent HVAC blocks
- full automatic, semi-automatic, dynamic semi-automatic and slave modes
- output of measured light value to the bus
- master-slave operation to expand detection area
- corridor function
- forced shutdown (switchoff)
- comprehensive options to temporarily block the detector
- freely-definable behaviour on bus voltage return
- soft start
- regulation of two light groups using an offset
- intelligent central-OFF function
- access to lighting scenes
- orientation lighting
- burn-in function for fluorescent lamps (selectable from 1 hour to 100 hours)
- variable safety pause after switching lights off
- options for fine tuning of regulation
- occupancy-independent regulating mode
- switchable LEDs

Using the optional remote control or with communication objects (visualisation), the following settings can be made or adjusted during operation:

- change to follow-up time
- change to brightness threshold / set value brightness
- switch between semi-automatic and full automatic mode
- activate or deactivate burn-in function
- switch on or off display LEDs
- activate/deactivate test mode

1.3 Symbols

In the following application description, various symbols are used for clarity. These symbols are briefly explained here.



Attention:

This symbol denotes sections of text which absolutely must be read, in order to avoid mistakes in project configuration and commissioning.



Recommendation:

This symbol denotes parameter settings which, in our experience, lead to optimal use of the equipment.

2. OCCUPANCY DETECTOR BASICS

2.1 Introduction

To provide a simple introduction to this application description, we need to discuss the general functions of an occupancy detector. The essential functional groups are motion detection, light analysis and the internally-stored analysis.

2.2 Motion detection with the B.E.G. KNX occupancy detector

The KNX occupancy detector works on a passive infrared system, which registers heat movements and converts them to signals that can be analysed by a processor. The most important factor in motion detection is the right choice of mounting location.



Mounting location

The occupancy detector should be mounted so that the main direction of motion is always tangential (side-to-side across the device).



The following sources of interference can lead to unwanted triggering, since they can also produce differences in temperature:

1. radiant heaters
2. ventilation systems which emit hot or cold air
3. lights directly in the detection area

Accordingly, the detector must be positioned far from these sources.



If even the smallest movements are to be recognised (e.g. working at a computer keyboard), we recommend that you choose a mounting location directly above the desk. This will ensure that detection takes place.



Please always follow the mounting height given for the units. Smaller mounting heights reduce the range. Greater mounting heights increase the range but also reduce sensitivity.

2.3 Difference between occupancy and motion detectors

Occupancy and motion detectors both automatically control the light, based on people being present (motion) and on ambient light levels.

Both detector types switch the light on if ambient light levels are below a brightness threshold (which can be set on the device) and movement is detected.

A motion detector switches it off again once no more movement is detected during the follow-up time, i.e. it remains switched on so long as it detects movements (independent of the lighting level). By contrast, an occupancy detector additionally switches the light off, independently of movement, once the ambient light level has been above the calculated switch-off threshold for a minimum time.

2.4 Switching mode and regulating mode

The detector can operate in two modes: switching mode and regulating mode. In switching mode, the light is switched on and off using 1-bit switching telegrams. For this, a switch actuator is required on the actuator side. In regulating mode, a dimming actuator is required. 1-byte dimming telegrams (percent values) are sent to the bus.

The desired brightness level for the room can be freely selected. In switching mode, the term brightness threshold is used. This specifies the brightness threshold under which the detector should switch on the light. If a threshold of 500 lux is set, and the ambient light (daylight) level is 200 lux, the detector switches on when motion is detected (1). The increase in light caused by the selected lamp is measured (2). With a 600 lux increase in light, the detector switches off (3) as soon as the sum of the increase in light and the rise in ambient light reaches 1100 lux. Therefore the selected light level (increase in light) is no longer available. The ambient light is now 500 lux (1100 lux - 600 lux), which is exactly the value defined as brightness threshold.

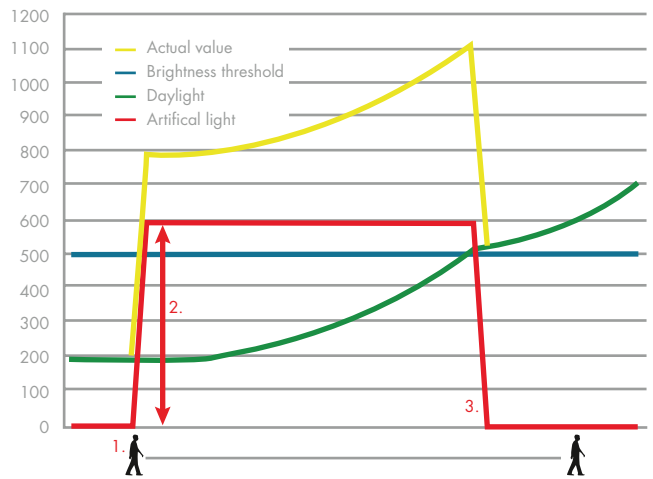

With lighting regulation, the term used is not brightness threshold, but set value. Here, the detector sends a dimming telegram to the bus. If the ambient light (daylight) level is under the set value, and the detector registers a movement (1), the light switches on (100%). Then, using the brightness level determined (2), the light is dimmed until the set value is reached. From now on, the detector regulates the light (3) and keeps the room brightness at a constant value (set value), until the proportion of artificial light reaches 0% (4).

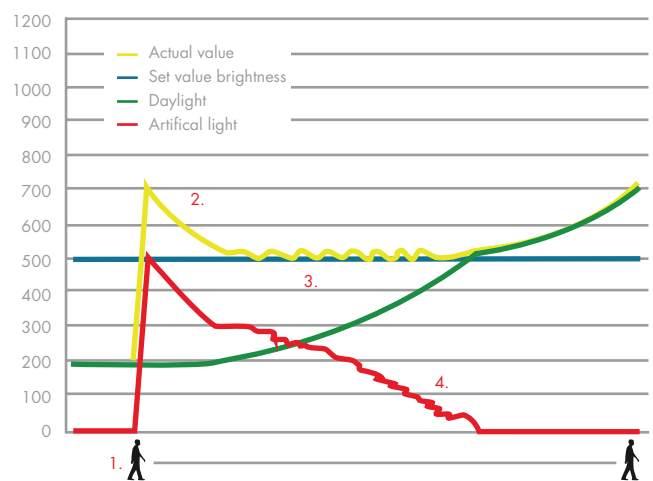

2.5 Light analysis

The occupancy detector switches the light automatically, depending on the people being present (movements) and on ambient light. The light sensor integrated into the detector continually measures ambient light and compares it with the brightness threshold or set value set in the detector. If ambient light is sufficient, the lighting is not switched on (A). If ambient light is below the defined set value brightness, any movement in the room will cause the lighting to switch on (B).

The detector switches the lighting off even if a person is present if there is enough natural light (C) or no movement is detected in the room for a given follow-up time.

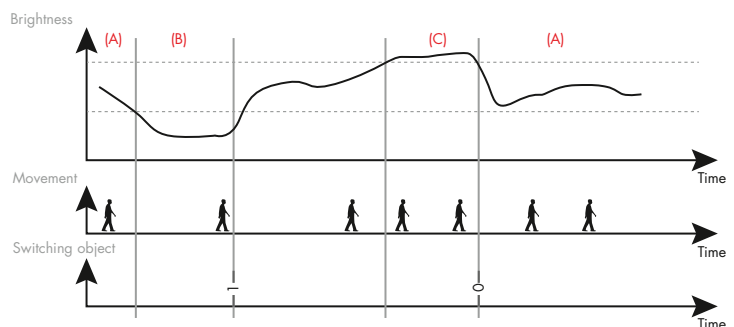

2.6 Detector operating modes

The detector can operate in the following modes:

1. Full automatic mode
In this mode, the lighting switches on and off automatically, according to occupancy and brightness, for greater convenience.
2. Semi-automatic mode
In this mode, the lighting only switches on by manual operation, for improved energy saving. Switching off takes place automatically or manually. Semi automatic mode behaves essentially in the same way as full automatic mode. The difference is that switch-on must always be manual.
3. Slave mode
In this mode, the device only detects movement and sends this information to the master. With more than one detector per light group, at least one device must be set as master. All other detectors must be set to slave mode. Only the master decides whether the lighting is to be switched on/off or dimmed.
4. Occupancy-independent regulating mode
In this mode, the detector operates as brightness sensor (permanent dimmer), i.e. motion data is not analysed.

2.7 Detector functional groups

The occupancy detector has various functional groups. The most important is light output. In this group, the basic function of the occupancy detector is performed. Here, motion and brightness information is analysed, switching and regulation takes place, and changes between the different modes are made.

Light output also includes the option to run the detector as a slave. This is required for systems that need an expanded detection area. Several detectors then work in conjunction. In slave mode, the other light output functions are no longer available.

In addition, three HVAC channels (heating, ventilation and air conditioning) are available. These channels are for the control of energy-intensive systems such as air conditioning.

As well as these functional groups, the detector also requires an administration group. Here, general settings are activated, including calibration of the light sensor.

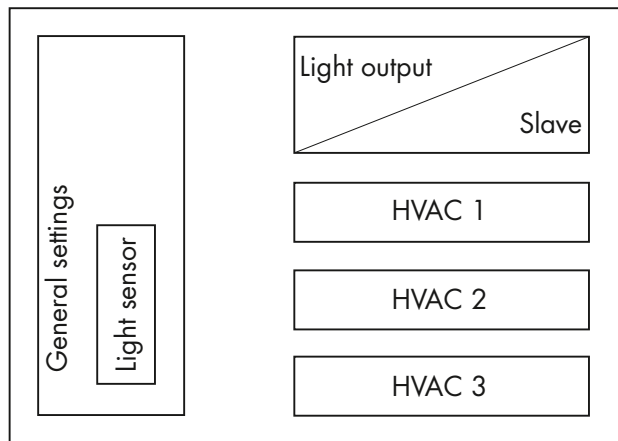

3. IR REMOTE CONTROL (optional)

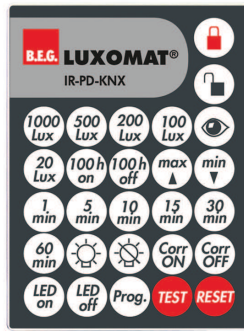

In addition, **B.E.G.** KNX occupancy and motion detectors can be controlled via the KNX bus using infrared (IR) remote control. The optional IR-PD-KNX remote control, item no. 921 23, is available as an accessory.

3.1 Special functions

RESET The "Reset" button resets the detector. Here, the detector behaves as it does on bus voltage return (see section 5.13). The parameter settings activated there are used.

Prog. The "Prog." button puts the detector in programming mode, in order to program a physical KNX address.

3.2 Operating modes and remote control buttons

Depending on the detector's current mode, some remote control functions may be blocked. The detector's mode can be modified by KNX telegrams. The following five modes exist:

- Not programmed: The detector has not yet been programmed or "downloaded" by ETS
- Standard: The detector is working in normal mode (master)
- Slave: The detector is working in slave mode
- Test: The detector is in test mode
- Locked: The detector is locked

Lock In each mode (except for when the detector is locked), the detector can be locked or unlocked with the remote control. In locked mode, there are generally fewer remote control functions available.

		not programmed		standard mode		slave mode		test mode		locked	
		lock	unlock	lock	unlock	lock	unlock	lock	unlock	lock	unlock
											
Set value/threshold 1.000 Lux					✓				✓		
Set value/threshold 500 Lux					✓				✓		
Set value/threshold 200 Lux					✓				✓		
Set value/threshold 100 Lux					✓				✓		
Read-in current light value					✓						
Set value/threshold 20 Lux					✓				✓		
Burn-in function on					✓				✓		
Burn-in function off					✓				✓		
Dim up					✓						
Dim down					✓						
Follow-up time 1 min					✓				✓		
Follow-up time 5 min					✓				✓		
Follow-up time 10 min					✓				✓		
Follow-up time 15 min					✓				✓		
Follow-up time 30 min					✓				✓		
Follow-up time 60 min					✓				✓		
Light on					✓				✓		
Light off					✓				✓		
Corridor function on					✓				✓		
Corridor function off					✓				✓		
LED on					✓		✓		✓		
LED off					✓		✓		✓		
KNX programming button			✓		✓		✓		✓		
Test mode on/off				✓	✓				✓		
Reset		✓	✓	✓	✓	✓	✓	✓	✓		

4. GENERAL SETTINGS

4.1 Activate/deactivate outputs

If light output or one of the three HVAC/occupancy channels is activated, additional parameter settings appear, for setting up detail functions.

 Only when a channel is activated do its parameters and communication objects appear.

General settings	
Light output:	Deactivated
	Activated
HVAC/Presence - Output 1:	Deactivated
	Activated
HVAC/Presence - Output 2:	Deactivated
	Activated
HVAC/Presence - Output 3:	Deactivated
	Activated

4.2 Test mode

Test mode is for checking the detection area. If movement is detected, the lighting switches on for 2 seconds and then off again. The duration of switch-off depends on the length that was set up for the safety pause.

Test mode can be activated as follows:

-  with a 1-bit "1" telegram on the "Test mode - Input - General" communication object
- with the "Test" button on the remote control
- with both the communication object and the remote control

Test mode can be deactivated at any time as follows:

-  automatically after 3 minutes
- after the "Reset" button on the remote control is operated
- with a "0" telegram on the "Test mode - Input - General" communication object

 The test mode function must first be activated in General Settings.



General settings	
Test mode:	Deactivated
	Activation via communication object
	Activation via remote control
	Activation via communication object/ remote control

No.	Name	Function	Length	C	R	W	T	DPT
0	Test mode - Input	General	1 bit	C	-	W	-	1.001

4.3 LED

Since the integrated LED can be detected as a source of interference in some locations, there is an option to switch it off after programming with ETS.

The LED can be switched off and on as follows:

-  using the "LED - Input - General" communication object (1-bit "0" telegram: switch off / 1-bit "1" telegram: switch on)
-  with the "LED off" and "LED on" buttons on the remote control
- with both the communication object and the remote control

General settings	
LED:	Activated
	Deactivatable/Activatable via communication object
	Deactivatable/Activatable via remote control
	Deactivatable/Activatable via communication object/ remote control

No.	Name	Function	Length	C	R	W	T	DPT
2	LED - Input	General	1 bit	C	-	W	-	1.001

 In the "Activated" setting, there is no option to switch off the LED after download.

4.4 Safety pause

The safety pause is to prevent optical feedback and reactivation with no movement, for example because of thermal interference. It is defined as the shortest period between switching off and switching back on the lighting.

Light output	
Safety pause in seconds:	1 - 60 [3]

5. LIGHT OUTPUT SETTINGS

5.1 Basic settings

During project configuration, it is advisable first to set parameters for mode (full automatic, semi-automatic, slave or occupancy-independent regulation) and output type (switching or regulation). Output type affects the output object. In switching mode, a 1-bit object (15: Switching channel - Output) is used, and in regulating mode a 1-byte object (16: Value 1 - Output).

After that, it is recommended that you define the brightness threshold or set value and the follow-up time. Following these basic settings, the detector is ready for service. All other settings/parameters are for optimisation or for adjustment in particular situations.

Light output	
Operating mode detector:	Fully automatic mode
	Semi-automatic mode
	Slave mode
	Occupancy-independent regulating mode
Output type:	Switching
	Regulating
Follow-up time in seconds:	0 - 59 [0]
Follow-up time in minutes:	0 - 59 [10]
Follow-up time in hours:	0 - 24 [0]
Threshold value brightness: 5 ... 1200 Lux	5 - 1200 [500]

No.	Name	Function	Length	C	R	W	T	DPT
15	Switching channel - Output	Light output	1 bit	C	R	-	T	1.001
16	Value 1 - Output	Light output	1 byte	C	R	-	T	5.001

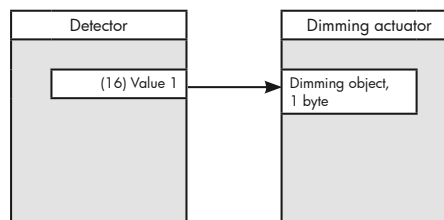
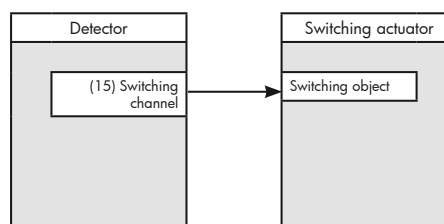

5.2 Output type

The "Output type" parameter defines whether the detector should work in switching or regulating mode. In regulating mode, the detector regulates the brightness to the set value given. The corresponding dimming actuators on the opposite side are used for this.

In switching mode, the detector only switches on and off. Normally, this is performed via 1-bit switching telegrams. Switch actuators are to be found on the opposite side.

However, instead of 1-bit telegrams, 1-byte or scene telegrams can also be sent. Here, the detector is in switching mode, i.e. it is not regulated, but when switching on, the 1-bit switching telegram is replaced with a value telegram (0-100%) or a scene number. The same applies for switching off.

Switching mode

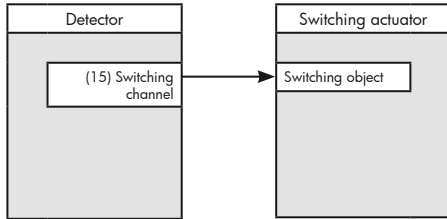
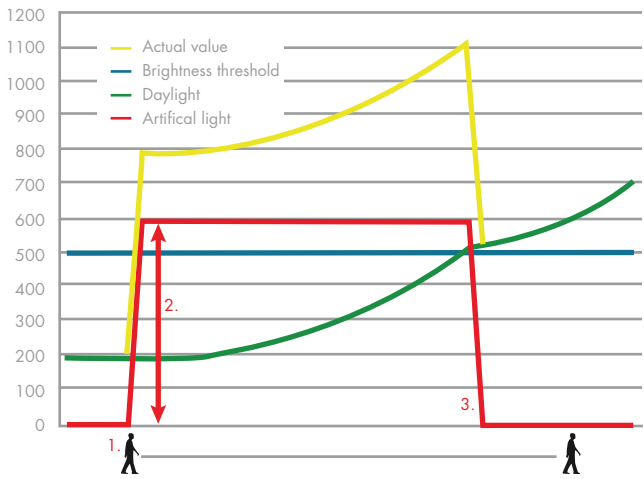

Switching mode 1 bit

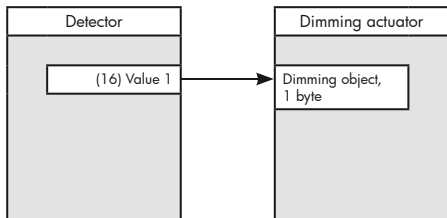

Switching mode 1Byte

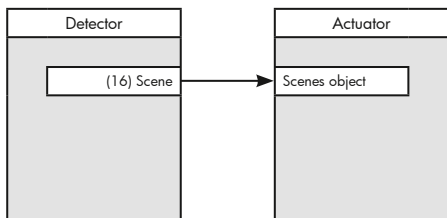
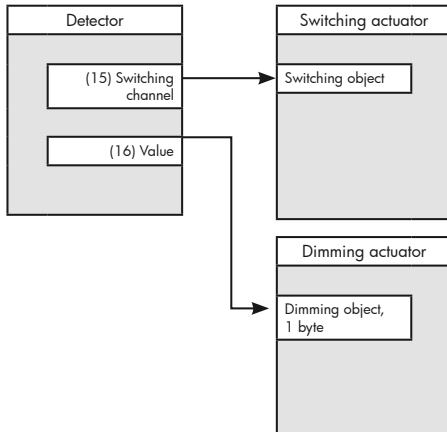

Regulating mode

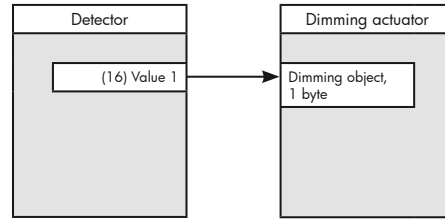
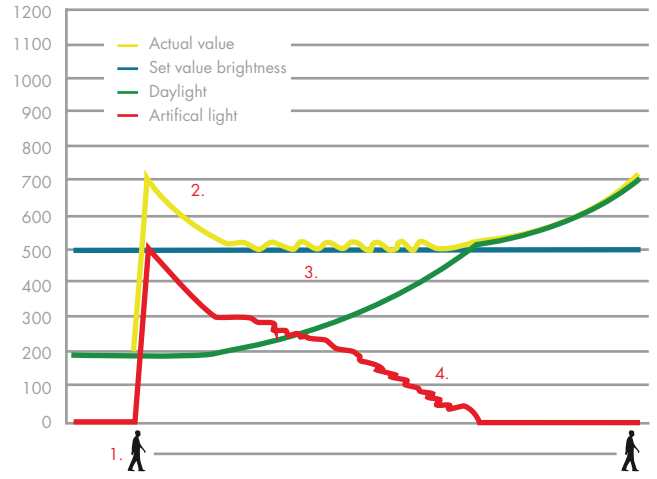

Dimming mode 1 byte

Light output

Output type:	Switching
	Regulating
Output: (visible if output type switching)	Switching mode 1 bit
	Switching mode 1 byte
	Switching mode 1 bit 1 byte
	Scenes mode
Value upon channel activation: 0 ... 255 = 0 ... 100% (visible if 1 byte)	0 – 255 [255]
Value upon channel deactivation: 0 ... 255 = 0 ... 100% (visible if 1 byte)	0 – 255 [0]
Scene upon channel activation: (visible if scene)	1 – 64 [1]
Value upon channel deactivation: (visible if scene)	1 – 64 [2]

No.	Name	Function	Length	C	R	W	T	DPT
15	Switching channel - Output	Light output	1 bit	C	R	-	T	1.001
16	Value-Output	Light output	1 byte	C	R	-	T	5.001
16	Value 1 - Output	Light output	1 byte	C	R	-	T	5.001
16	Scene - Output	Light output	1 byte	C	R	-	T	17.001

5.3 "Follow-up time" parameter

The follow-up time determines how long the lighting remains on after the last detected movement. Each new movement restarts the follow-up time. Follow-up time is set under "Follow-up time in seconds", "Follow-up time in minutes" and "Follow-up time in hours", and is produced by adding these three times.

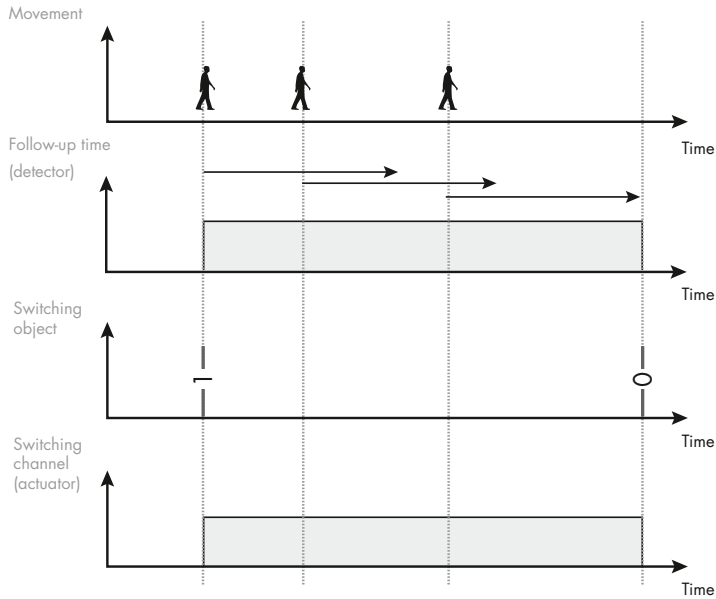

i With fluorescent lamps, a follow-up time of at least 10 minutes is recommended, to increase the lifespan of the lamp.

Light output	
Follow-up time in seconds:	0 – 59 [0]
Follow-up time in minutes:	0 – 59 [10]
Follow-up time in hours:	0 – 24 [0]

i The shortest follow-up time is approx. 100 ms (input of 0/0/0).

The occupancy detector follow-up time can be changed via the "Follow-up time in minutes – Input – Light output" communication object and/or by remote control.

The communication object is a 2-byte object. Follow-up time is given in minutes.

🔒 Using the remote control (optional), predefined follow-up times can be set (1 min, 5 min, 10 min, 15 min, 30 min, 60 min). The detector must previously have been unlocked for this (grey button, open lock).

As soon as a new value has been specified via remote control or via the "Overwrite follow-up time in minutes – Input" communication object, the occupancy detector works with the newly specified time.

Light output	
Overwrite follow-up time:	Deactivated
	Activation via communication object
	Activation via remote control
	Activation via communication object/remote control

No.	Name	Function	Length	C	R	W	T	DPT
7	Follow-up time in minutes - Input	Light output	2 byte	C	-	W	-	7.006

5.4 Daylight-dependent switch-off

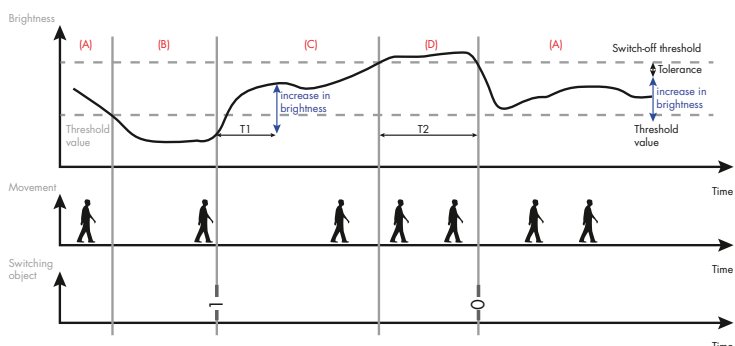

In the example (switching mode), the light value is initially above the brightness threshold. There is no reaction in terms of light output when movement is detected (A). If the light value falls below the threshold, and the occupancy detector detects movement, the lighting is switched on (B).

The curve (brightness) describes the total light intensity in a room with daylight and artificial light. After the lighting is switched on, time T1 starts. This time can be set in the parameters under "Calculate threshold for switching off after". As seen in the diagram, fluorescent lamps for example only reach their maximum brightness after a few minutes. After time T1, the switch-off threshold is calculated. The increase in brightness achieved in time T1 is added to the threshold in the parameter settings. In addition, a selectable tolerance is added to this value. In regulating mode, this setting does not apply, as regulation is made to the set value.

During the time in which the actual light level is below the switch-off threshold, any movements which occur re-trigger the follow-up time, so that the lighting remains on (C).

If the proportion of daylight rises slowly to (C) and exceeds the switch-off threshold (D), delay time T2 starts. This is Daylight-dependent shutdown (switchoff), which causes the lighting to be switched off although the follow-up time has not yet expired. The light value over this time must remain above the switch-off threshold. This function is for energy saving. The lighting switches off after time T2. In regulating mode, T2 cannot be changed. The duration here is 60 seconds.



For fluorescent lamps, we recommend a duration of 5-10 minutes. For resistive loads such as incandescent lamps, a duration of 5 minutes is sufficient.

Daylight-dependent shutdown (switchoff) is not to be confused with follow-up time.

Light output	
Calculate threshold for switching off after:	1 minute
(visible, if Output type is switching)	5 minutes
Follow-up time in minutes:	0 – 59 [10]
Follow-up time in hours:	0 – 24 [0]

5.5 Manual control options

The main task for a detector is automation of lighting. This results in energy saving from the lighting (light is only switched on if it is really needed), as well as increased convenience (light switches on automatically or constant light regulation maintains even illumination in the workplace). To fulfil these tasks, the detector switches or regulates the light actuators (switching actuators, dimming actuators).



The detector contains all the sensors and analyses the values measured by them for switching or regulating the lighting. Therefore, there are no further components required, such as light sensors, timers or connectors. Manual intervention in lighting control is not recommended, as this may cause behaviour that can be interpreted as errors. The light fitting controlled by the detector may not be influenced by other KNX sensors (apart from the detector).

In switching mode, the detector switches the light on (100%) or off (0%). It therefore has two states. Automatic operation can be controlled externally through the "External influence – Input – Light output" object. An external switch (via the KNX bus) can cause the detector to switch the connected actuators. The reaction varies according to the parameter settings selected.

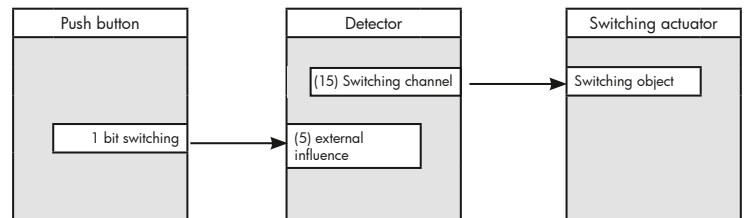

No.	Name	Function	Length	C	R	W	T	DPT
5	External influence - Input	Light output	1 bit	C	-	W	-	1.001
15	Switching channel - Output	Light output	1 bit	C	R	-	T	1.001

Alternatively, the detector's locking function can be used to set the connected actuator to a fixed position (off or on, no automatic operation).

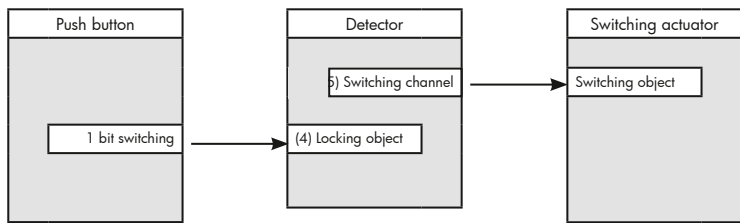

No.	Name	Function	Length	C	R	W	T	DPT
4	Locking object - Input	Light output	1 bit	C	-	W	-	1.001
15	Switching channel - Output	Light output	1 bit	C	R	-	T	1.001

In regulating mode, there are more than two states (on and off). It is often desired to dim to a value between 0% and 100%, which should then be maintained without any automatic adjustment. For this, the locking function can be used. When activating a lock, a 1-byte telegram can be sent, to set the dimming actuator to the desired value. This is a fixed value. It cannot be changed or modified during operation.

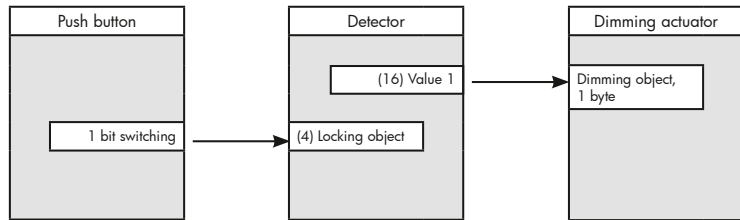

No.	Name	Function	Length	C	R	W	T	DPT
4	Locking object - Input	Light output	1 bit	C	-	W	-	1.001
16	Value 1 - Output	Light output	1 byte	C	R	-	T	5.001

Also, the detector only offers the option to dim the actuator using a push button. This manual dimming must be transmitted to the detector using the "Manual Dimming - Input - Light output" object. The KNX dimming push button (4 bit) now sends the dimming commands to both the dimming actuator and the detector. The detector then no longer sends dimming telegrams to the actuator via the "Value 1/2 - Output - Light output" objects. Only the switch-off telegram is transmitted, after the expiry of the follow-up time (no more people in the room). Finally, the occupancy detector reverts to the mode set in the parameters.

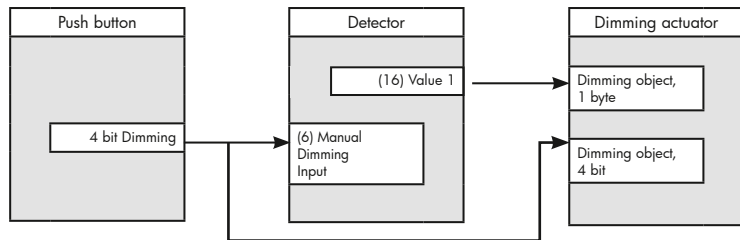

No.	Name	Function	Length	C	R	W	T	DPT
6	Manual Dimming - Input	Light output	4 bit	C	-	W	-	3.007
16	Value 1 - Output	Light output	1 byte	C	R	-	T	5.001

In addition, manual dimming is available via the optional remote control. In this case, dimming commands are transmitted from the remote control to the detector. The detector forwards these values to the dimming actuator via the "Manual dimming - Output - Light output" object.

The max button increases the light level for as long as it is pressed, and the min button dims the light level for as long as it is pressed (equivalent to KNX 4-bit dimming). The detector must be set to unlocked for this.

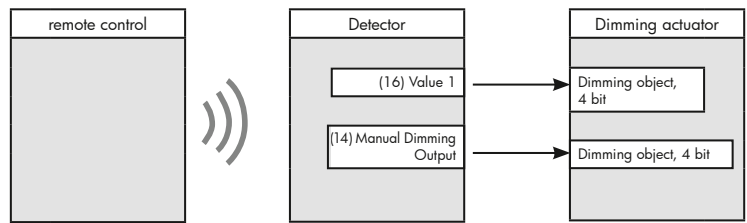

No.	Name	Function	Length	C	R	W	T	DPT
14	Manual Dimming - Output	Light output	4 bit	C	R	-	T	3.007
16	Value 1 - Output	Light output	1 byte	C	R	-	T	5.001

5.6 Brightness threshold 1 and 2 (switching) or set value 1 and 2 (regulating)

The set value or brightness threshold is the lux value desired for the room. This can be freely selected in a range of 5-1200 lux.

- Recommended values (room brightness):
- Transit areas: approx. 200 lux
- Working areas: approx. 600 lux
- Detailed or close-up activities: approx. 1000 lux

In switching mode, two brightness thresholds can be stored. These two values can be swapped using the 1-bit object "Toggle threshold value 1 and 2 - Input". When a swap takes place, the 1-bit object "Current threshold - output" sends a response. Here, "0" telegrams describe threshold 1 and "1" telegrams threshold 2.

As well as this fixed brightness threshold preset, the respective first value can be overwritten using the 2-byte object "Overwrite threshold 1 - Input - Light output".

When unlocked, there is also the option to change the values using the optional remote control. Here, the following values are available: 100 lux, 200 lux, 500 lux and 1000 lux.

Light output (visible when switching mode)	
Threshold value 1 brightness: 5 ... 1200 Lux	5 - 1200 [500]
Activate additional threshold?	No Yes
Threshold value 2 brightness: 5 ... 1200 Lux (visible if additional threshold is activated)	5 - 1200 [1200]
Overwrite threshold value 1	Deactivated Activation via communication object Activation via remote control Activation via communication object/ remote control

No.	Name	Function	Length	C	R	W	T	DPT
8	Overwrite threshold 1 - Input	Light output	2 byte	C	-	W	-	9.004
9	Toggle threshold 1 and 2 - Input	Light output	1 bit	C	-	W	-	1.003
15	Switching channel - Output	Light output	1 bit	C	R	-	T	1.001
18	Current threshold - Output	Light output	1 bit	C	R	-	T	

In regulating mode, the term set value is used instead of brightness threshold. As well as set value 1 and 2, there is another value, the fixed value. A fixed value is defined if, for example, regulation should not occur at night, but instead the light should be switched on at a particular value when movement is detected. If the fixed value is activated, the detector works as a movement detector and not an occupancy detector (no regulation function). It merely switches the light on regardless of brightness level.

A 1-bit "0" or "1" telegram can be used to switch to and fro between set values 1 and 2 and the fixed value.

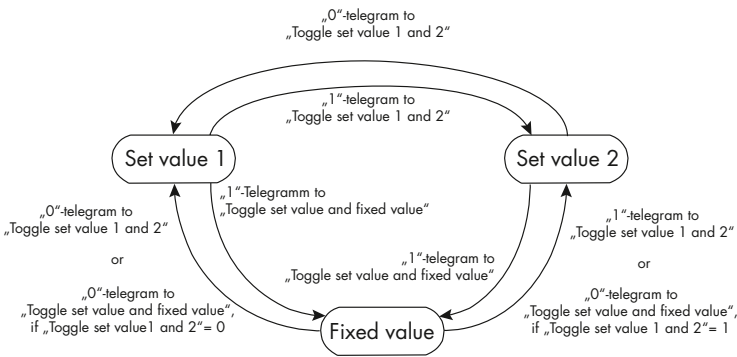

On a mode change, the currently active mode is sent back via a response object, and can be queried via the "Actual set value/fixed value – output" communication object: set value 1 = 1; set value 2 = 2; fixed value = 3.

Light output (visible in Regulating mode)	
Set value 1 brightness: 5 ... 1200 Lux	5 – 1200 [500]
Activate additional set value?	No Yes
Set value 2 brightness: 5 ... 1200 Lux (visible, if additional set value is activated)	5 – 1200 [1200]
Fixed value: 0 ... 100 % (visible, if additional set value is activated)	0 – 100 [0]
Overwrite set value 1:	Deactivated Activation via communication object Activation via remote control Activation via communication object/ remote control

No.	Name	Function	Length	C	R	W	T	DPT
8	Overwrite set value 1 - Input	Light output	2 byte	C	-	W	-	9.004
9	Switch set value 1 and 2 - Input	Light output	1 bit	C	-	W	-	1.003
10	Switch set value and Fixed value - Input	Light output	1 bit	C	-	W	-	1.003
16	Value 1 Output	Light output	1 byte	C	R	-	T	5.001
18	Current set value/ Fixed value - Output	Light output	1 bit	C	R	-	T	1.003

5.7 Change trigger function

In full automatic mode, the occupancy detector is activated by detection of a movement. In contrast to full automatic, semi-automatic mode means that switch-on must occur manually. This takes place via a 1-bit "1" telegram on the "External influence – Input – Light output" object.

 It is possible to swap between full automatic and semi-automatic modes during operation using a communication object (Switch-on upon movement – Input) and/or the remote control while the detector is unlocked.

Communication object 13, "Switch-on upon movement – Input", is visible if the parameter "Change trigger function" is set to "Activation via communication object" or "Activation via communication object/remote control". This parameter also covers use of the remote control. If the parameter setting for the detector is full automatic mode, it can be swapped to semi-automatic mode and back. A 1-bit "1" telegram switches the detector to full automatic mode, and a 1-bit "0" telegram to semi-automatic mode.

Light output

Change trigger function:	Deactivated
	Activation via communication object
	Activation via remote control
	Activation via communication object/ remote control

No.	Name	Function	Length	C	R	W	T	DPT
5	External influence - Input	Light output	1 bit	C	-	W	-	1.001
13	Switch on upon movement - Input	Light output	1 bit	C	-	W	-	1.003

5.8 Dynamic semi-automatic mode / daylight-dependent resetting

In semi-automatic mode, the detector must be manually switched on by an external push button (via the KNX bus). The detector automatically switches off for one follow-up time no movement has been detected or the ambient light is bright enough.

However, natural light often fluctuates considerably, for example because of passing clouds. If the detector has switched off the light because it is bright enough, it must be reactivated manually when daylight drops, which, for example could disrupt the working routine in an office.

By activating the "Daylight-depending resetting" parameter, this behaviour can be influenced. After the detector has switched off because ambient light is bright enough, the follow-up time continues to run in the background. So long as there is movement, this time will keep being restarted. If the follow-up time is still running, and the ambient light falls under the selected threshold, the detector switches back on automatically if the parameter has been activated (without the use of an external switch) when movement is detected.

Then, the external push button only has to be used if no movement is detected for an entire follow-up time, for example if everybody has left the room.

Light output	
Daylight-depending resetting:	Deactivated Activated

5.9 Manual switching-on in case of sufficient ambient light / forced shutdown (switchoff)

In full automatic mode, the detector automatically switches on as soon as it detects movement and ambient light is too low. If switch-on is also permitted via an external switch at high ambient light levels (above the selected threshold), this must be enabled through a parameter (Manual switching-on in case of sufficient ambient light).

In semi-automatic mode, the detector must essentially be switched on manually. Here, a parameter defines whether the detector can be switched on only at a brightness level below the selected brightness threshold, or also above it.

If the detector is switched on manually at a high ambient light level (above the selected threshold), its behaviour depends on the selected mode:

- In switching mode, the detector switches on the lighting and remains active as long as there are people in the room. After the follow-up time has expired, the lighting switches off (re-triggered by each new movement). If forced shutdown is active, the lighting is switched off after 15 minutes if the ambient light is continuously bright enough.
- In regulating mode, the detector switches on the lighting at 10% for the duration of the follow-up time (re-triggered by each new movement) or for forced shutdown (switchoff), for 15 minutes, as long as brightness remains above the set value. As soon as the light level falls below the set value when the lighting is active, lighting regulation is used (starting from 10%).

Manual switching-on when ambient light is sufficient reduces the potential for saving energy. With forced shutdown (switchoff), the manually "forced" switch-on period can be limited to 15 minutes. This parameter is visible once the "Manual switch-on in case of sufficient ambient light" parameter is activated. Forced shutdown (switchoff) is active if a manual switch-on takes place at sufficient ambient light levels. If it continues to be bright enough for 15 minutes, the regulating/switching channel is switched off. In regulating mode, if brightness falls below the set value, normal regulation is used.

Light output	
Manual switching-on in case of sufficient ambient light:	Deactivated
	Activated
Forced shutdown: (visible, when manual switching-on is activated)	Deactivated
	Activated

No.	Name	Function	Length	C	R	W	T	DPT
5	External influence-Input	Light output	1 bit	C	-	W	-	1.001

5.10 Centralised switching

If the detector has switched on the light because of a movement, the light can be switched off early by a 1-bit "O" telegram on the central object. This central-OFF command can be performed with a delay. During the delay period, the detector checks whether there is still movement taking place in the room. If movement is detected during the delay time, this aborts the central-OFF function.

Example: The caretaker switches the lights off centrally in the evening. However, the light may only be switched off if there are in fact no more people in the office. If monitoring via the delay period is not required, the time is set to zero.

 Each channel (light and HVAC) can be set separately to respond to a central-OFF command or not.

Light output	
Reaction via central object:	Deactivated
	Activated
Delay time via central object in seconds:	0 – 60 [0]



No.	Name	Function	Length	C	R	W	T	DPT
1	Central-OFF - Input	General	1 bit	C	-	W	-	1.017

5.11 Corridor function

If the detector has switched on the light in full automatic mode, it can be switched off manually via the "External influence – Input" object. After receiving the telegram via the object, the light remains switched off for the follow-up time that has been set despite any movements, and any movement during this time restarts the follow-up time. This function may be useful for presentations, for example, where the light has to remain off. This is the case if corridor function is deactivated.

In offices, the following disadvantage can occur: At closing time, the workers leave the office and turn off the light. In the corridor, a worker realises they have forgotten something, and goes back into the office. If corridor function is deactivated, the light does not switch on in this case. By contrast, if corridor function is activated, after manual switch-off, the detector returns to normal mode after a short time, i.e. when the worker goes back into the office, motion is detected and the light is switched on. The time for corridor function can be freely selected between 1 and 60 seconds.

 Semi-automatic mode precludes corridor function.

  Corridor function can also be activated via remote control. For this, the "Corridor function" and "Corridor function via remote control" parameters must be activated, and the detector must be in an unlocked state.

Light output	
Corridor function:	Deactivated
	Activated
Corridor function via remote control:	Deactivated
	Activated
Time corridor function in seconds:	1 – 60 [5]

No.	Name	Function	Length	C	R	W	T	DPT
5	External influence-Input	Light output	1 bit	C	-	W	-	1.001

5.12 Locking function

The locking function allows the occupancy detector to be locked, so that no telegrams are sent to the bus. The locking function is available for both switching and regulating modes for lighting, and also for the three HVAC channels. You must select a locking value to choose which 1-bit object value ("1" or "0") should activate locking.

When transitioning from unlocked to locked, an action can be triggered. A decision has to be made on which state light output is in. If the channel is switched on, i.e. a follow-up time runs, the locking can cause the situation in which this follow-up time expires before locking is activated ("Locking prevents the channel from being activated"). Then the channel is locked. Alternatively, locking can be active immediately. Here, there is the option to send an ON telegram, an OFF telegram or no telegram as an action.

Reaction upon unlocking can also trigger an action: send an ON telegram, OFF telegram or no telegram. If an ON telegram is sent, follow-up time is automatically started.

For locking, a dimming value (0-100%) can be set on a regulation output. If the device is unlocked, it automatically jumps back to its normal regulating mode.

While the locking function is active, the remote control cannot be used.

Light output (visible in switching mode)	
Locking via object possible:	Lock with OFF-telegram
	Lock with ON-telegram
	Lock inactive
Function when locking: (visible, when locking is activated)	Locking prevents the channel from being activated
	Lock only
	Lock with OFF-telegram
	Lock with ON-telegram
Function when unlocking: (visible, when locking is activated)	Unlock only
	Unlock with OFF-telegram
	Unlock with ON-telegram

No.	Name	Function	Length	C	R	W	T	DPT
4	Locking object-Input	Light output	1 bit	C	-	W	-	1.001

Light output (visible in regulating mode)	
Locking via object possible:	Lock with OFF-telegram
	Lock with ON-telegram
	Lock inactive
Function when locking: (visible, when locking is activated)	Locking prevents the channel from being activated
	Lock only
	Lock and transmit value
Value transmitted when locking: 0 ... 100% (visible if lock and transmit value)	0 ... 100 [100]

No.	Name	Function	Length	C	R	W	T	DPT
4	Locking object-Input	Light output	1 bit	C	-	W	-	1.001

5.13 Bus voltage return

After bus voltage return, the detector requires a 60-second initialisation time, during which it records neither motion nor brightness. During initialisation, it is possible to switch a connected actuator on or off. If all connected loads are switched on at the same time after a bus voltage return, this overloads the supply. Conversely, if the connected loads are not switched on, there is a danger that the room remains dark and people could be injured.

The "Bus voltage return" parameter lets you define how the detector should behave on bus voltage return. For this, there are three selection options:

- 1) the connected loads are switched on
- 2) the connected loads are switched off
- 3) the state before bus voltage failure is restored

After bus voltage return, the detector sends corresponding telegrams via its output objects (via "Switching channel – Output – Light output" in switching mode; and via "Value 1 – Output – Light output" and "Value 2 – Output – Light output" in regulating mode).

i For the HVAC/occupancy outputs, the “Detector transmits” parameter can be used to define which telegrams the detector sends to the bus. Behaviour defined under this parameter is taken into account on bus voltage return.

i In regulating mode, there are two output objects (“Value 1 – Output – Light output” and “Value 2 – Output – Light output”). These behave the same way on bus voltage return. Both can send 0% or both 100%.

Light output	
Bus voltage return	Same behaviour as for channel activation (switch on)
	Same behaviour as for channel deactivation (switch off)
	Same behaviour as prior to bus voltage failure

No.	Name	Function	Length	C	R	W	T	DPT
15	Switching channel – Output	Light output	1 bit	C	R	–	T	1.001
16	Value 1 - Output	Light output	1 byte	C	R	–	T	5.001
17	Value 2 - Output	Light output	1 byte	C	R	–	T	5.001

5.14 Additional functions in regulating mode

5.14.1 Regulation (dimming) of two light groups (offset)

If there is a requirement to regulate 2 light groups differently, this can be achieved using an offset. The base channel is defined as the “Value 1 – Output” communication object. If for example an offset of -30% is set in the parameters, the second channel switches on when the base channel has exceeded 30%. There is a permanent 30% difference in the regulated value between the two objects “Value 1 – Output” and “Value 2 – Output”. If the base channel reaches 100%, then the second channel is automatically increased to 100%.

Note: It is not possible to control two light groups independently, i.e. with two different set values

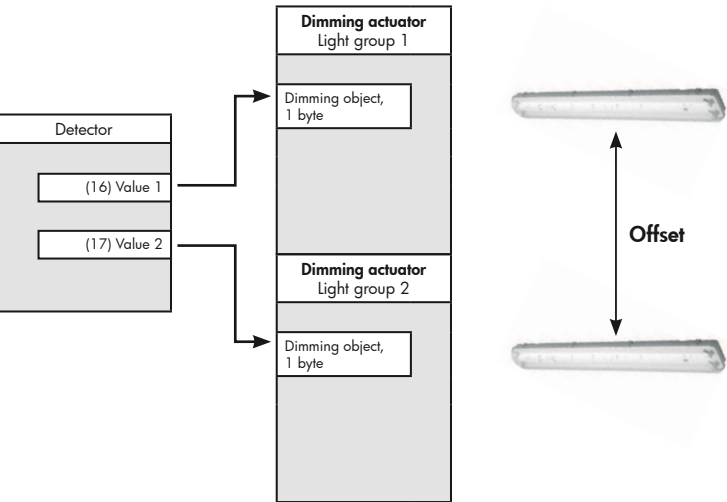

Light output	
(visible when regulating mode is selected)	
Offset between brightness value 1 and 2: -100% ... 100%	-100 ... 100 [0]

No.	Name	Function	Length	C	R	W	T	DPT
16	Value 1 - Output	Light output	1 byte	C	R	–	T	5.001
17	Value 2 - Output	Light output	1 byte	C	R	–	T	5.001

5.14.2 Soft start

When motion is detected, the detector initially switches on the lighting to 100%, and then regulates it to the set value. With the soft start function activated, the detector regulates from 0% to the set value when motion is detected.

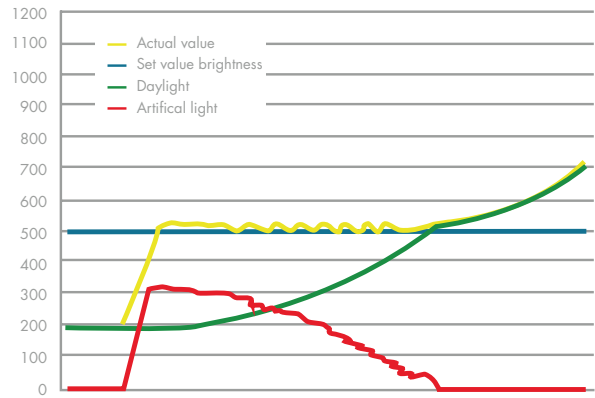
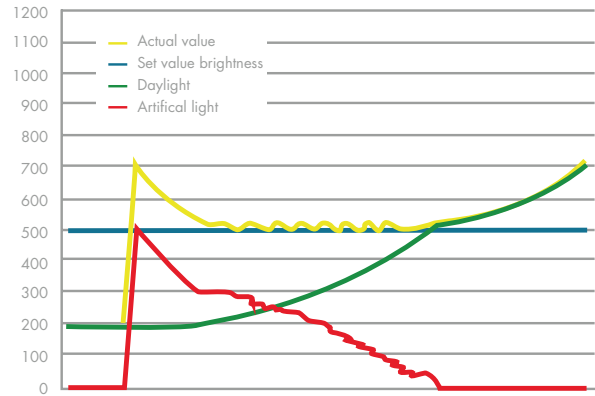

Light output	
(visible in regulating mode)	
Soft start:	Off ON

No.	Name	Function	Length	C	R	W	T	DPT
16	Value 1 - Output	Light output	1 byte	C	R	–	T	5.001
17	Value 2 - Output	Light output	1 byte	C	R	–	T	5.001

5.14.3 Orientation light

The orientation light function is for providing dimmed lighting after the selected follow-up time has expired. This can be set as a percentage. Provision of dimmed lighting can be time-limited or permanently-on while no motion is detected and ambient light levels remain below the selected value.

In orientation lighting, the selected offset between the “Value 1 – Output” and “Value 2 – Output” objects is set to 0%.

Light output	
(visible in regulating mode)	
Orientation light:	Off Permanent With time restriction
Orientation light fixed value [%]: 1 ... 100% (visible if permanent / with time restriction is selected)	1 ... 100 [10]
Orientation light: 5 ... 120 minutes (visible if with time restriction is selected)	5 ... 120 [5]

No.	Name	Function	Length	C	R	W	T	DPT
16	Value 1 - Output	Light output	1 byte	C	R	–	T	5.001
17	Value 2 - Output	Light output	1 byte	C	R	–	T	5.001

5.14.4 Burn-in function for fluorescents

Before they are dimmed, new fluorescent lamps should be burned in for a certain period, to ensure a long life and flicker-free operation. The application provides a parameter for this, "Lamp burn-in function", which can be activated or deactivated. If the function is activated, lamps will always be 100% switched on or completely switched off for the burn-in period. Regulation to the set value is not available.

The prerequisite for this is that the lights are not controlled directly via a dimmer switch, as shown in the following arrangement:

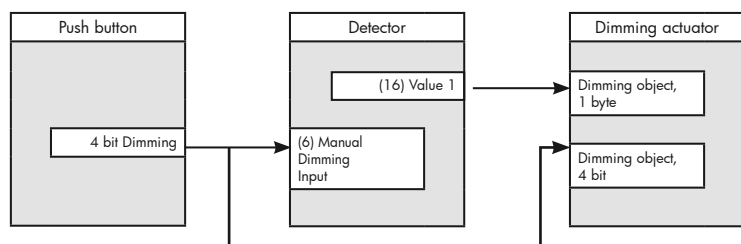

Burn-in time can be selected between 1-100 hours. There is an option to terminate a running burn-in time early, as long as the "Interrupt burn-in function" is activated. Therefore a conscious decision has to be taken as to whether termination of the burn-in function should be permitted.

The current state of the burn-in time (time remaining) can be accessed via the "Retrieve burn-in time - Input" communication object, and is given via the "Burn-in time status - Output - Light output" object.

100h on If the burn-in function is activated, this can be started with the optional remote control ("100h ON" button), via a communication object ("1" telegram to the "Start/stop burn-in function - Input" object) or via both methods.

100h off If termination of the burn-in function is permitted, burn-in can be terminated early by pressing the "100h OFF" button, by a "0" telegram to the "Start/stop burn-in function - Input" object, or via both methods.

Light output (visible in regulating mode)	
Lamp burn-in function	Deactivated Activated
Activate burn-in function via: (visible when burn-in function is activated)	Remote control Communication object Communication object and remote control
Interrupt burn-in function: (visible when burn-in function is activated)	Deactivated Activated
Burn-in time in hours: (visible when burn-in function is activated)	1 ... 100 [100]

No.	Name	Function	Length	C	R	W	T	DPT
11	Start/Stop burn-in function - Input	Light output	1 bit	C	-	W	-	1.010
12	Retrieve burn-in time- Input	Light output	1 bit	C	-	W	-	1.010
16	Value 1 - Output	Light output	1 byte	C	R	-	T	5.001
17	Value 2 - Output	Light output	1 byte	C	R	-	T	5.001
19	Burn-in time status - Output	Light output	2 byte	C	R	-	T	

5.14.5 Regulation cycle time (Cycle time for controlling)

The "Cycle time for controlling" parameter controls the time delay between individual regulation telegrams.

If telegrams are sent too closely together, this can cause the lighting to fluctuate. Therefore, the standard time for this parameter is 3 seconds. If lighting fluctuation occurs, the "Cycle time for controlling" parameter must be set to a longer delay.

Light output (visible in regulating mode)	
Cycle time for controlling:	200 milliseconds 1 second 2 seconds 3 seconds 4 seconds 5 seconds

5.14.6 Regulation minimum

This parameter determines the minimum value to which the detector can regulate. For example, some fluorescent lamps can develop colour casts if the light value is too low. The minimum value, selectable between 1% and 9%, is set to avoid these unwanted effects.

Light output (visible in regulating mode)	
Regulation minimum:	1% 2% 3% 4% 5% 6% 7% 8% 9%

5.15 Additional functions in switching mode

5.15.1 Send ON-telegrams during follow-up time

The parameter "Send ON-telegram" determines whether the detector sends an ON telegram only at the first triggering or at every movement detected. If the "Only upon first movement" option is selected, the number of telegrams sent to the bus is minimised, reducing bus load.

For special applications, the detector has the option to send an ON telegram for every movement detected. For example, this can be useful to determine how often there is movement in the room and if necessary to reduce the duration of the follow-up time accordingly. However, there is more load on the bus in this setting.

Light output (visible in switching mode)	
Send ON-telegram:	Only upon first movement Upon every detection

6. HVAC OPERATION

6.1 Introduction

The occupancy detector's light output is optimised for control of lights (switching or dimming). In addition to this output, the detector has three HVAC channels (HVAC = heating, ventilation and air conditioning). These channels are optimised for energy-intensive applications, for example air conditioning.

An HVAC channel functions in a similar way to the light output switching channel. However, the range of functions and the factory settings are more suited to HVAC applications. For example, dimming is not possible, and an HVAC channel normally works independently of brightness levels.

Examples:

1) When entering an office, the lighting should switch on immediately (light output), but the air conditioning should only switch on when a person stays in the room for at least 5 minutes. Therefore, on a short visit to an office, only the light should switch on automatically, and not the air conditioning. As well as energy saving, a further advantage is that the air conditioning unit is protected, as it is not being continuously switched on and off again.

2) There are two light groups in a classroom. The lighting output controls these with a fixed offset from the set value. The teacher's board should be controlled via a separate switch, independent of the light groups. An HVAC channel can also be used for this purpose.

6.2 Differences between light output and HVAC channels

The functions of an HVAC channel are similar to those for light output. A description of the functions can be taken from the corresponding sections for light output. Below, we concentrate on the differences between light output and HVAC channels.

An HVAC channel can either switch on automatically, as soon as a movement is detected (full automatic), or it must be switched on via an external KNX push button (semi-automatic). In both cases, it switches off automatically (unless set otherwise in the parameter settings). Swapping between full automatic and semi-automatic modes can be carried out via an object.

Follow-up time is freely selectable. Input is made in hours, minutes and seconds. Follow-up time can be changed via the bus using a 2-byte object.

An HVAC channel normally functions independent of brightness, as opposed to a light output. However, it is possible to set parameters for an HVAC channel to depend on brightness. Different brightness thresholds can be defined for each channel. These can also be changed via the bus using 2-byte telegrams.

HVAC channels are switching channels. However, under the "Detector transmits" parameter, it can be defined whether (a) both ON and OFF telegrams, or (b) only ON or OFF telegrams are sent.

HVAC/Presence – Output 1 (bis 3)	
Operating mode detector:	Fully automatic mode
	Semi-automatic mode
Follow-up time in seconds:	0 – 59 [0]
Follow-up time in minutes:	0 – 59 [10]
Follow-up time in hours:	0 – 24 [0]
Overwrite follow-up time:	Deactivated
	Activation via communication object
Light-dependant switching:	Deactivated
	Activated
Threshold value brightness: 5 ... 1200 Lux (visible when light-dependant switching is selected)	5 ... 1200 [500]
Overwrite threshold: (visible when light-dependant is selected)	Deactivated
	Activation via communication object
Detector transmits:	ON- and OFF-telegram
	Only ON-telegram
	Only OFF-telegram
Safety pause in seconds:	0 – 60 [3]
Change trigger function:	Deactivated
	Activation via communication object
Reaction via central object	No response
	Deactivated channel
Delay time via central object in seconds: (visible, if channel deactivatable)	0 – 60 [0]
Locking via object possible:	Lock with OFF-telegram
	Lock with ON-telegram
	Lock inactive
Function when locking:	Locking prevents the channel from being activated
	Lock only
	Lock with OFF-telegram
	Lock with ON-telegram
Function when unlocking:	Unlock only
	Unlock and OFF-telegram
	Unlock and ON-telegram
Bus voltage return	Same behaviour as for channel activation
	Same behaviour as for channel deactivation
	Same behaviour as prior to bus voltage failure

No.	Name	Function	Length	C	R	W	T	DPT
20	Locking object - Input	HVAC 1	1 bit	C	-	W	-	1.001
21	External influence - Input	HVAC 1	1 bit	C	-	W	-	1.001
22	Follow-up time in minutes - Input	HVAC 1	2 byte	C	-	W	-	7.006
23	Overwrite threshold - Input	HVAC 1	2 byte	C	-	W	-	9.004
24	Switch on upon movement - Input	HVAC 1	1 bit	C	-	W	-	1.003
25	Presence - Output	HVAC 1	1 bit	C	R	-	T	1.001
26	Locking object - Input	HVAC 2	1 bit	C	-	W	-	1.001
27	External influence - Input	HVAC 2	1 bit	C	-	W	-	1.001
28	Follow-up time in minutes - Input	HVAC 2	2 byte	C	-	W	-	7.006
29	Overwrite threshold - Input	HVAC 2	2 byte	C	-	W	-	9.004
30	Switch on upon movement - Input	HVAC 2	1 bit	C	-	W	-	1.003
31	Presence - Output	HVAC 2	1 bit	C	R	-	T	1.001
32	Locking object - Input	HVAC 3	1 bit	C	-	W	-	1.001
33	External influence - Input	HVAC 3	1 bit	C	-	W	-	1.001
34	Follow-up time in minutes - Input	HVAC 3	2 byte	C	-	W	-	7.006
35	Overwrite threshold - Input	HVAC 3	2 byte	C	-	W	-	9.004
36	Switch on upon movement - Input	HVAC 3	1 bit	C	-	W	-	1.003
37	Presence - Output	HVAC 3	1 bit	C	R	-	T	1.001

6.3 Delayed switch-on

Depending on the usage of an HVAC channel, it can be useful to switch on the devices connected to it, such as HVAC equipment, with a time delay. The "Activation time" parameter is used to define whether the channel is switched on directly when movement is detected, or after a delay. If a delayed reaction is desired, this parameter must be set to "Observation time". In this case, other parameters become visible, which allow definition of the switch-on delay time (Number of observation windows, Observation time in seconds/minutes).

Up to 20 observation windows can be defined per HVAC channel. The duration defined under the "Observation time in seconds" and "Observation time in minutes" parameters applies to all windows (1-60 seconds and 0-60 minutes). At least one movement must be detected in each window to allow the channel to switch on.

Example: Three observation windows each with an observation time of 10 seconds.

After the first detected movement (A), the detector starts window 1. If no movement is detected within its duration of 10 seconds, evaluation is terminated. If at least one movement is detected (B), after the first window's time has elapsed (C), the second observation window is started. Here too, evaluation is terminated if no movement is detected within the duration of the window. If at least one movement is detected (D), the third window is started (E). If more than three windows are set in the parameters, this is repeated for the total number of observation windows. The detector switches on as soon as the last window has detected its first movement (F). So in this example, this will result in a delay time of 21-30 seconds (depending on when the last movement is detected). If there is no movement in a window, all windows are reset.

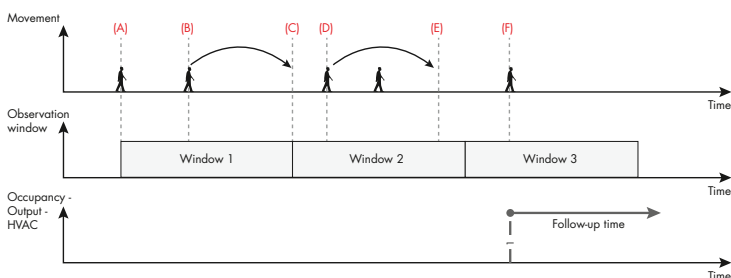

The observation time ensures that there is movement for the defined duration before the connected load is switched on. In this way, sources of interference can partly be filtered out.

Example:

The detector is a motion detector, which is attached on the outside wall of a house to control the exterior lighting. The observation window prevents an animal scurrying by from triggering a switch-on. Conversely, the house occupants can be sure that, if the light has been switched on, motion has been detected on their property or in their garden for a longer time, for example by a person who is on their property (or else by an animal staying in their garden for a long time).

Note:

The **B.E.G.** motion and occupancy detectors are not a certified alarm. They are not suitable for use in alarm installations.

HVAC/Presence – Output 1 (bis 3)	
Activation time	Switch on immediately upon movement
	Observation time
Number of observation windows: <small>(visible when „Observation time“ is selected)</small>	1 – 20 [3]
Observation time in seconds: <small>(visible when „Observation time“ is selected)</small>	1 – 60 [3]
Observation time in minutes: <small>(visible when „Observation time“ is selected)</small>	0 – 60 [0]

7 OCCUPANCY-INDEPENDENT REGULATING MODE

In occupancy-independent regulating mode, the detector analyses the brightness level and regulates lighting independently of movement. This is advantageous if a particular light level should be maintained regardless of whether people are present, for example in bank lobbies or passageways. The detector switches the light on when brightness levels fall below a set value, and regulate it to that set value. If the proportion of daylight increases and exceeds the set value, the detector switches the light off again.

The parameter structure for occupancy-independent regulating mode corresponds to that for normal regulating mode. The relevant parameters and their functions can be found in the description of regulating mode.

If continuous lighting regulation at particular times is not desired, it can be switched off permanently using a locking object.

If the detector is switched on manually (“External influence” object) at a high ambient light level above the selected set value, the lighting is switched on at 10% for a duration of 15 minutes, so long as the light level does not fall below the set value. Forced shutdown (switchoff) cannot be deactivated in occupancy-independent regulating mode. As soon as the light level falls below the set value when the lighting is active, lighting regulation is used (starting from 10%).

 If the detector is switched off with the central-OFF function/object while in occupancy-independent regulating mode, it can no longer switch itself back on, as movement information is not analysed in this mode. If the central-OFF function is used, the “External influence” object must additionally be activated, with which the system can be put back into regulating mode (ON telegram). The central-OFF object affects all detector blocks (light output and three HVAC blocks), but external commands only affect light output.

 By contrast to occupancy-dependent regulating mode, the central-OFF command in occupancy-independent regulating mode switches the lights off immediately, as the detector does not check if there are still people in the detection area.

Light output <small>(in occupancy-independent regulating mode)</small>	
Operating mode detector:	Occupancy-independent regulating mode
Set value 1 brightness: 5 ... 1200 Lux	5 – 1200 [500]
Activate additional set value?	No Yes
Set value 2 brightness: 5 ... 1200 Lux <small>(visible if additional set value is activated)</small>	5 – 1200 [1200]
Fixed value: 0 ... 100 % <small>(visible if additional set value is activated)</small>	0 – 100 [0]
Overwrite set value 1	Deactivated Activation via communication object Activation via remote control Activation via communication object/ remote control

Cycle time for controlling:	200 milliseconds
	1 second
	2 seconds
	3 seconds
	4 seconds
	5 seconds
Regulation minimum:	1%
	2%
	3%
	4%
	5%
	6%
	7%
	8%
	9%
Safety pause in seconds:	0 – 60 [3]
Soft start:	Off
	On
Offset between brightness value 1 and 2: -100% ... 100%	-100 ... 100 [0]
Reaction via central object	No response
	Deactivated channel
Manual switching-on in case of sufficient ambient light:	Deactivated
	Activated
Forced shutdown: <small>(visible when manual switching on is selected)</small>	Activated
Lamp burn-in function	Deactivated
	Activated
Activate burn-in function via: <small>(visible when burn-in function is activated)</small>	Remote control
	Communication object
	Communication object and remote control
Interrupt burn-in function: <small>(visible when burn-in function is activated)</small>	Deactivated
	Activated
Burn-in time in hours: <small>(visible when burn-in function is activated)</small>	1 ... 100 [100]
Locking via object possible:	Lock with OFF-telegram
	Lock with ON-telegram
	Lock inactive
Function when locking: <small>(visible if locking activated)</small>	Lock only
	Lock and transmit value
Value transmitted when locking: <small>0 ... 100% (visible if transmit value is selected)</small>	0 ... 100 [100]

No.	Name	Function	Length	C	R	W	T	DPT
1	Central-OFF - Input	General	1 bit	C	-	W	-	1.017
3	Slave - Input	General	1 bit	C	-	W	-	1.016
4	Locking object - Input	Light output	1 bit	C	-	W	-	1.001
5	External influence - Input	Light output	1 bit	C	-	W	-	1.001
9	Toggle set value 1 and 2 - Input	Light output	1 bit	C	-	W	-	1.003
10	Switch set value and fixed value - Input	Light output	1 bit	C	-	W	-	1.003
11	Start/Stop burn-in function - Input	Light output	1 bit	C	-	-	-	1.010
12	Retrieve burn-in time-Input	Light output	1 bit	C	-	-	-	1.010
16	Value 1 - Output	Light output	1 byte	C	R	-	T	5.001
17	Value 2 - Output	Light output	1 byte	C	R	-	T	5.001

18	Current set value/ fixed value - Output	Light output	1 bit	C	R	-	T	
19	Burn-in time status - Output	Light output	2 byte	C	R	-	T	7.006

8 MASTER-SLAVE SYSTEMS / OCCUPANCY DETECTORS IN SLAVE MODE

If an area larger than a detector's detection area is to be monitored, additional detectors can be set up in slave mode.

i Two master detectors in a lighting system can lead to problems. Since both masters analyse brightness levels and specify follow-up times, and can influence each other optically, this can lead to interference in both regulating mode and switching mode.

In a master-slave system, as many slaves as necessary feed one master. The master takes over all logical evaluation, such as brightness detection and specification of follow-up time. Slaves expand the range and are only for motion detection. As soon as a movement is registered, they send this information to the master.

i In a master-slave system, brightness measurement is carried out by the master. It monitors and analyses set values and brightness thresholds. These values always refer to the master's mounting location.

In simple systems, it is enough to connect all slave outputs to the master's slave input. If a slave detects a movement, it sends this information to the master. In order to minimise the load on the KNX bus from telegrams, telegrams from slaves are sent in a particular frame. The time between telegrams can be changed in the "Locking time slave" parameter. Times of under 30 seconds are not recommended. These are reserved for special cases. The time selected should not be greater than half the follow-up time installed in the master.

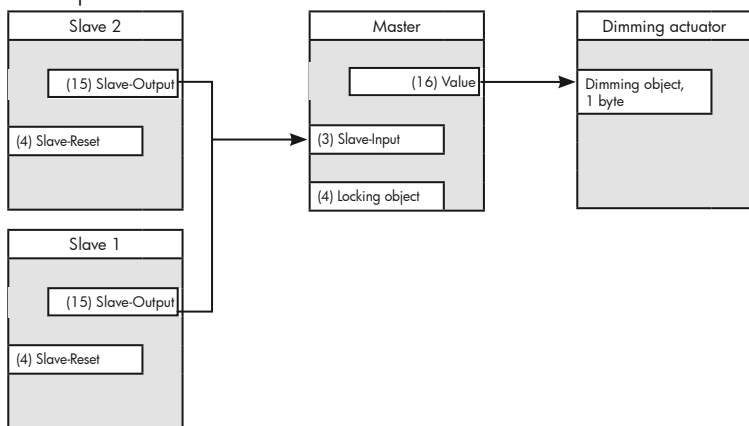

On systems that can be locked, this information is also required by the slaves, so that they can restart motion detection after a lock is removed. In this case, the slaves also send a telegram outside their time frame.

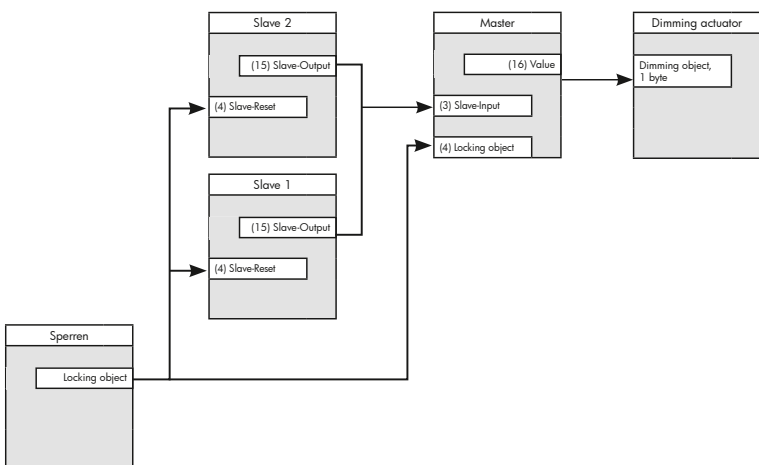

A **B.E.G.** KNX occupancy detector also has three HVAC channels as well as its base master and slave functions (light output). When setting up the parameters, the following options are available:

1. Detector is operating purely as a master
2. Detector is operating as a master and has additional HVAC channels
3. Detector is operating purely as a slave
4. Detector is operating as a slave and has additional HVAC channels

The slave input of a master affects both light output and the HVAC blocks.

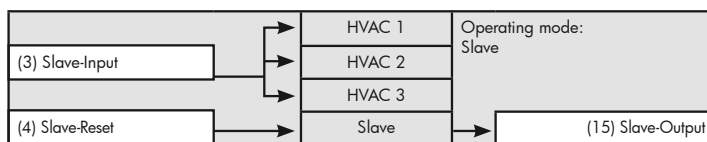
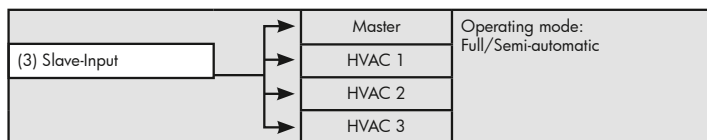

In the following example, the master is fed by two slaves. Slave 2 also has an HVAC channel. This HVAC channel is also triggered by slave 1. The HVAC channel should not control any light source, as in this case, lighting regulation is controlled by the master.

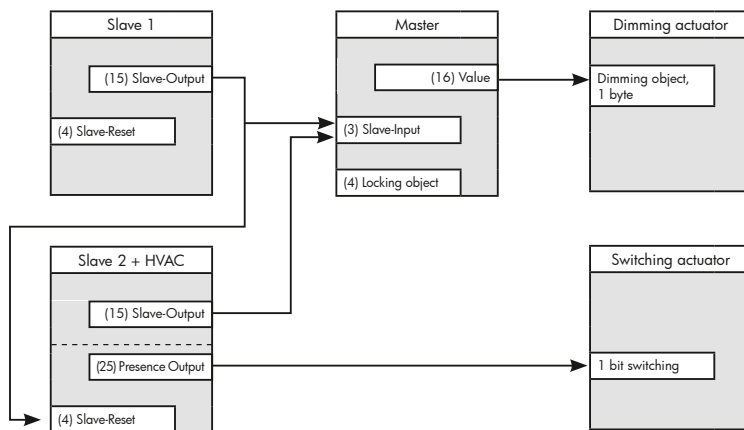

Light output

(visible in slave mode)

Locking time Slave:	1 second to 30 minutes [5 minutes]
Safety pause in seconds:	1 – 60 [3]

No.	Name	Function	Length	C	R	W	T	DPT
3	Slave - Input	General	1 bit	C	-	W	-	1.016
4	Slave - Reset	Light output	1 bit	C	-	W	-	1.017
15	Slave - Output	Light output	1 bit	C	R	-	T	1.016

8.1 Special case: Master-Master system

It is normally not advised to run two master units, each controlling one light group, in one room, since both masters can influence each other's regulation function.

However, there are cases which require a master-master system.

Classroom example:

There are two light groups, each independently controlled with a push button. Consequently, there are two different groups in the room, which are operated in semi-automatic mode. One master is required for each light group.

To ensure that motion detection in the room takes place consistently, one HVAC channel is connected to the slave input of the other master. The HVAC channel must be configured without delayed switch-on, and with a very short follow-up time. In this way, movement information for the whole room is exchanged, and each light group can still be switched independently.

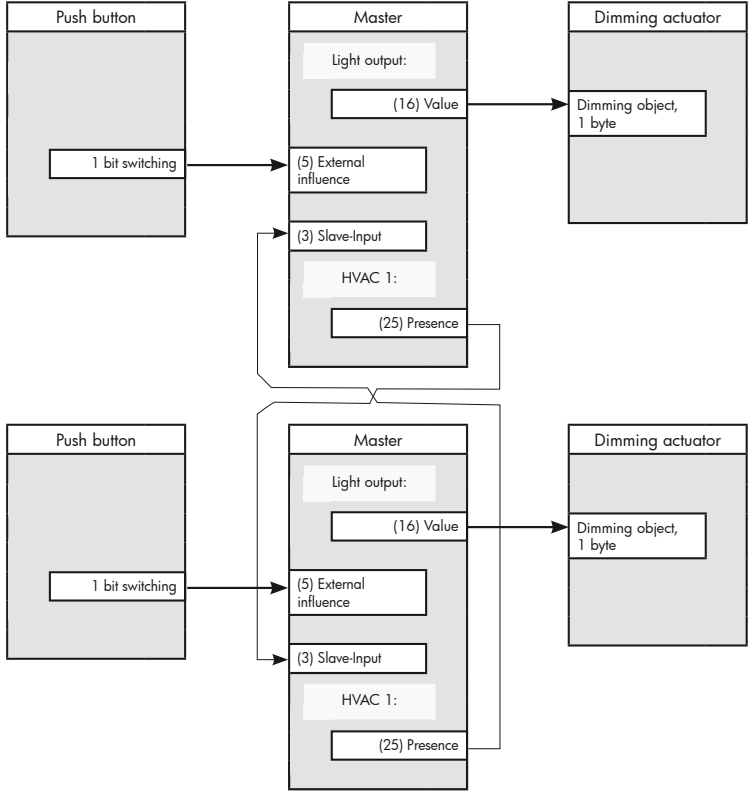

This gives a ratio of 1:2, so a reflection factor of 1/2 must be set.



It should be noted that in practice, because of fluctuations in daylight (passing clouds), documents on desks (white or dark sheets of paper), or the setting of window blinds for example, the reflection factor continually changes, so that there can be deviations from the desired/installed set value.

General settings	
Light sensor settings:	Deactivated
	Activated

Light sensor (visible when light sensor settings is activated)	
Reflection factor:	1
	1/2
	1/3
	1/4
	1/5

9 LIGHT SENSOR SETTINGS

9.1 Reflection Factor

An occupancy detector includes a light sensor to measure brightness. Since the detector is mounted on the room ceiling, it measures the light there too. This means that it measures light which is present in the room (as sunlight and artificial light) and which is reflected onto the ceiling. However, not all the light is reflected, as the reflection factor depends heavily on the surfaces and furnishings. The light value measured on the ceiling does not therefore represent the room brightness. Therefore, the reflection factor must be determined, and the KNX occupancy detector adjusted to local conditions.

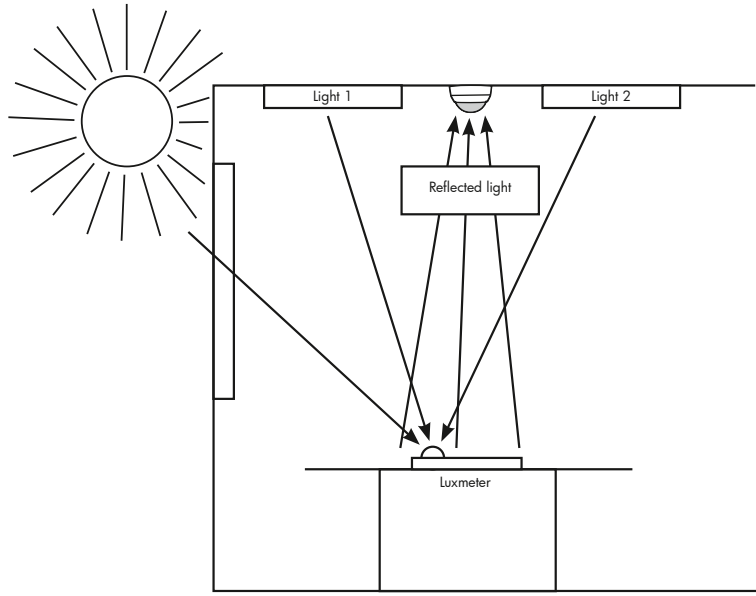

To determine the reflection factor, please proceed as follows:

1. Switch on the lighting. For fluorescent lamps, it is advisable to let them warm up for at least 10 minutes, so that they reach their maximum brightness.
2. Place a lux meter in the location where the desired lux value should be achieved, e.g. at a workstation, and measure the lux value.
3. Determine the brightness at the ceiling, i.e. at the occupancy detector. Hold the lux meter at the occupancy detector's location.

The relationship between the brightness measured at the ceiling and the brightness measured at the workstation represents the reflection factor.

Example:
 Measured value, ceiling 300 lux
 Measured value, desk 600 lux

9.2 Sending the light value / correction value

The light value measured can be sent to the KNX bus. After enabling this function, the corresponding objects are visible. This offers a choice between sending the light value at intervals or when it changes. For sending at intervals, a time delay can be defined for the change in light value and the amount of change.

If the lux value sent to the bus does not agree with the measured value, this can then be fine-tuned.

General settings	
Light sensor settings:	Deactivated
	Activated

Light sensor (visible when light sensor settings is activated)	
Correction value: -200 ... 200 lx	-200 – 200 [0] 1/2
Send lux value via object:	Send no light value
	Transmit light value in cycles
	Transmit light value in the event of changes
Send in cycles: (visible when „Transmit light value in cycles“ is selected)	1 second
	2 seconds
	5 seconds
	10 seconds
	30 seconds
	1 minute
	2 minutes
	3 minutes
	4 minutes
	5 minutes
	1 hour
Send upon change: (visible when „Transmit light value in the event of changes“ is selected)	Change > 10 Lux
	Change > 25 Lux
	Change > 50 Lux
	Change > 75 Lux
	Change > 100 Lux

No.	Name	Function	Length	C	R	W	T	DPT
38	Measured lux value - Output	Light sensor	2 byte	C	R	-	T	9.004

10. COMMUNICATION OBJECTS

No.	Name	Function	Length	C	R	W	T	DPT
0	Test mode - Input	General	1 bit	C	-	W	-	1.001
1	Central-OFF - Input	General	1 bit	C	-	W	-	1.017
2	LED - Input	General	1 bit	C	-	W	-	1.001
3	Slave - Input	General	1 bit	C	-	W	-	1.016
4	Slave - Reset	Light output	1 bit	C	-	W	-	1.017
4	Locking object - Input	Light output	1 bit	C	-	W	-	1.001
5	External influence - Input	Light output	1 bit	C	-	W	-	1.001
6	Manual Dimming - Input	Light output	4 bit	C	-	W	-	3.007
7	Follow-up time in minutes - Input	Light output	2 byte	C	-	W	-	7.006
8	Overwrite threshold 1 - Input	Light output	2 byte	C	-	W	-	9.004
9	Toggle threshold 1 and 2 - Input	Light output	1 bit	C	-	W	-	1.003
10	Switch set value and fixed value - Input	Light output	1 bit	C	-	W	-	1.003
11	Start/Stop burn-in function - Input	Light output	1 bit	C	-	W	-	1.010
12	Retrieve burn-in time - Input	Light output	1 bit	C	-	W	-	1.010
13	Switch on upon movement - Input	Light output	1 bit	C	-	W	-	1.003
14	Manual Dimming - Output	Light output	4 bit	C	R	-	T	3.007
15	Switching channel - Output	Light output	1 bit	C	R	-	T	1.001
15	Slave - Output	Light output	1 bit	C	R	-	T	1.016
16	Value - Output	Light output	1 byte	C	R	-	T	5.001
16	Scene - Output	Light output	1 byte	C	R	-	T	17.001
16	Value 1 - Output	Light output	1 byte	C	R	-	T	5.001
17	Value 2 - Output	Light output	1 byte	C	R	-	T	5.001
18	Current threshold - Output	Light output	1 bit	C	R	-	T	
19	Burn-in time status - Output	Light output	2 byte	C	R	-	T	7.006
20	Locking object - Input	HVAC 1	1 bit	C	-	W	-	1.001
21	External influence - Input	HVAC 1	1 bit	C	-	W	-	1.001
22	Follow-up time in minutes - Input	HVAC 1	2 byte	C	-	W	-	7.006
23	Overwrite threshold - Input	HVAC 1	2 byte	C	-	W	-	9.004
24	Switch on upon movement - Input	HVAC 1	1 bit	C	-	W	-	1.003
25	Presence - Output	HVAC 1	1 bit	C	R	-	T	1.001
26	Locking object - Input	HVAC 2	1 bit	C	-	W	-	1.001
27	External influence - Input	HVAC 2	1 bit	C	-	W	-	1.001
28	Follow-up time in minutes - Input	HVAC 2	2 byte	C	-	W	-	7.006
29	Overwrite threshold - Input	HVAC 2	2 byte	C	-	W	-	9.004
30	Switch on upon movement - Input	HVAC 2	1 bit	C	-	W	-	1.003
31	Presence - Output	HVAC 2	1 bit	C	R	-	T	1.001
32	Locking object - Input	HVAC 3	1 bit	C	-	W	-	1.001
33	External influence - Input	HVAC 3	1 bit	C	-	W	-	1.001
34	Follow-up time in minutes - Input	HVAC 3	2 byte	C	-	W	-	7.006
35	Overwrite threshold - Input	HVAC 3	2 byte	C	-	W	-	9.004
36	Switch on upon movement - Input	HVAC 3	1 bit	C	-	W	-	1.003
37	Presence - Output	HVAC 3	1 bit	C	-	W	T	1.001
38	Measured lux value - Output	Light sensor	2 byte	C	R	-	T	9.004